

# Highly sensitive pressure balance control inside clean rooms

## STAINLESS REGULATORS

- Optimum for carrier gas control in various kinds of solvents and pure water circuits, for blow pressure control, for clean air and gas pressure control used in liquid crystal or semiconductor-related processes, for other food product-related lines requiring corrosion resistance, and for other non-grease type or non-oil type lines.
- Contamination-controlled manufacturing process.

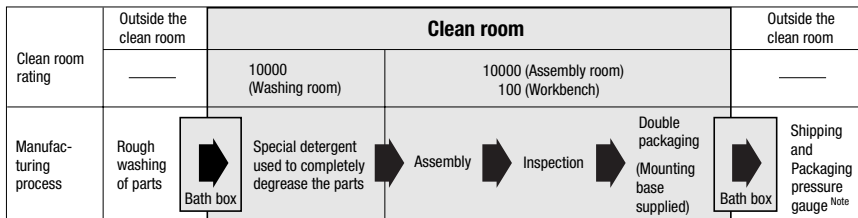

Note: The pressure gauge is just packed in single packaging at outside of the clean room.



- A push-lock mechanism is used in the pressure regulating knob.
- A mounting base for easy mounting is available as an option.
- The part that contacts gas uses SUS316, fluoro resin, or fluoro rubber materials.
- An optional pressure gauge is available.

### Application Example

- Pure water, solvent pressurized-supply line

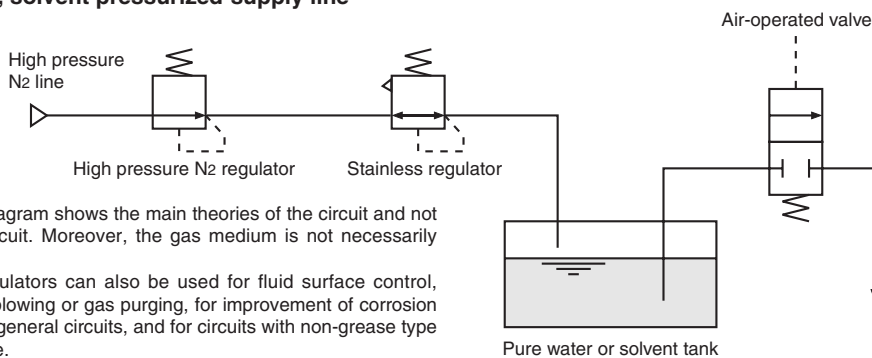

- ※ This circuit diagram shows the main theories of the circuit and not the actual circuit. Moreover, the gas medium is not necessarily limited to N<sub>2</sub>.
- ※ Stainless regulators can also be used for fluid surface control, including air blowing or gas purging, for improvement of corrosion resistance in general circuits, and for circuits with non-grease type or non-oil type.

### Symbols

- Relief

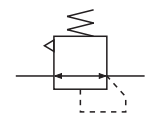

- Non-relief

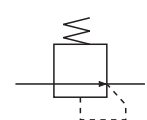

### Operation Principle and Inner Construction

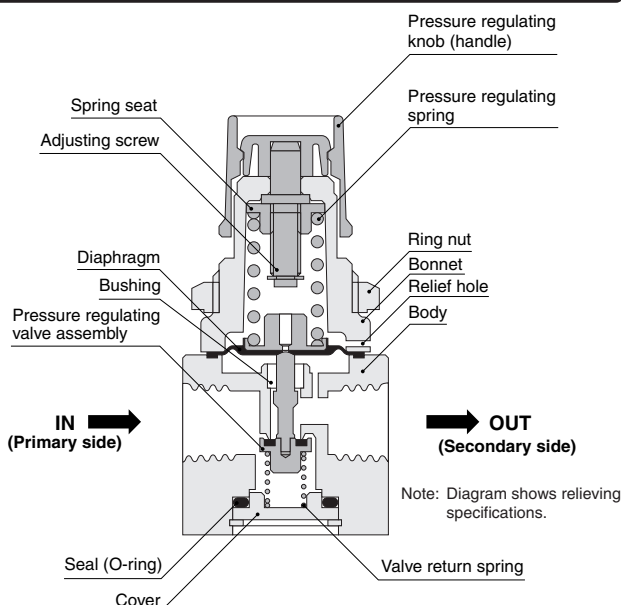

### Major Parts and Materials

Parts	Materials
Body	SUS316
Pressure regulating knob (handle)	Plastic (ABS)
Bonnet	Plastic (PBT)
Diaphragm	Fluoro rubber (FKM), or fluoro rubber (FKM) with fluoro resin (PTFE) lining
Pressure regulating spring	Piano wire (zinc plated)
Seal	Fluoro rubber (FKM)
Pressure regulating valve assembly	SUS316 + fluoro rubber (FKM), or SUS316 + fluoro rubber (FKM) with fluoro resin (PTFE) lining
Cover	SUS316
Bushing	Fluoro plastic (PTFE)
Valve return spring	SUS316
Adjusting screw	Brass (nickel plated)
Spring seat	Brass (nickel plated)
Plug (supplied)	SUS316
Ring nut	Mild steel (nickel plated)
Mounting base (optional)	SPCC (nickel plated)

## Order Codes

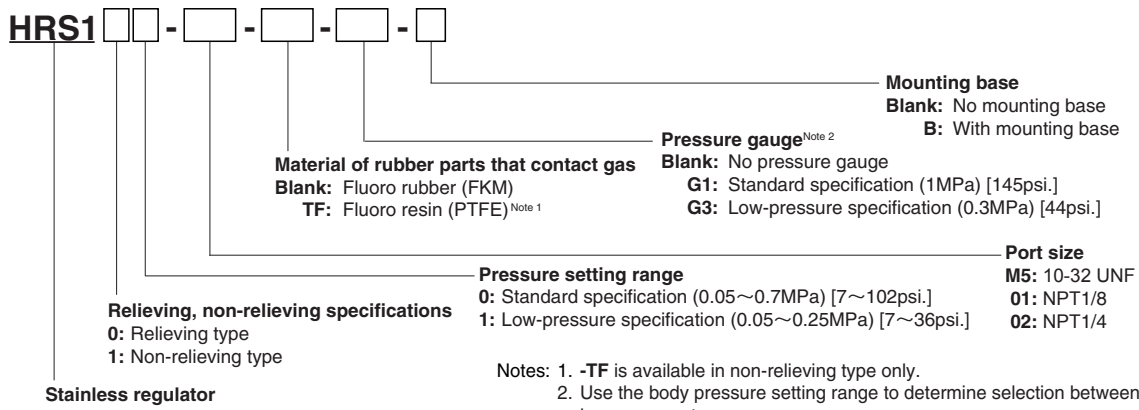

## Specifications

Item	Model	HRS10 □		HRS11 □	
		HRS100	HRS101	HRS110	HRS111
Media		Air, nitrogen, carbon dioxide, helium, argon		Air, nitrogen, oxygen, carbon dioxide, helium, argon	
Operation type		Diaphragm type			
Port size		10-32 UNF, NPT1/8, NPT1/4			
Pressure setting range	MPa [psi.]	0.05~0.7 [7~102]	0.05~0.25 [7~36]	0.05~0.7 [7~102]	0.05~0.25 [7~36]
Maximum operating pressure	MPa [psi.]	0.9 [131]			
Proof pressure	MPa [psi.]	1.5 [218]			
Operating temperature range	°C [°F]	5~60 [41~140]			
Mass	kg [lb.]	0.228 [0.503] (Including body, plug and hexagon nut)			
Optional	Material of valve and diaphragm that contacts gas	Fluoro rubber only (FKM)		Fluoro rubber (FKM), or fluoro plastic (PTFE)	
	Pressure gauge	G1: Standard specification (1MPa)	G3: Low-pressure specification (0.3MPa)	G1: Standard specification (1MPa)	G3: Low-pressure specification (0.3MPa)
	Mounting base	Base for mounting (mass: 0.035kg) [1.23oz.]			

## Dimensions of Stainless Regulators (mm)

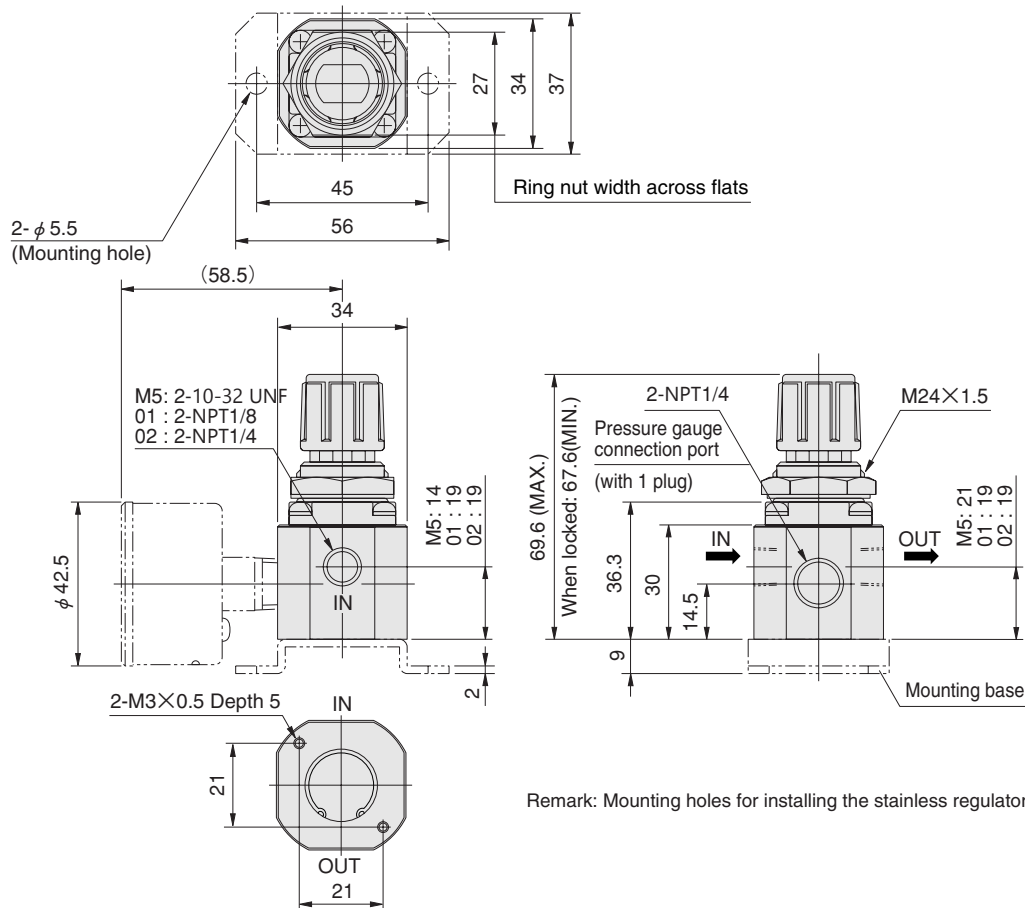

# Flow Rate Characteristics

● HRS100-M5

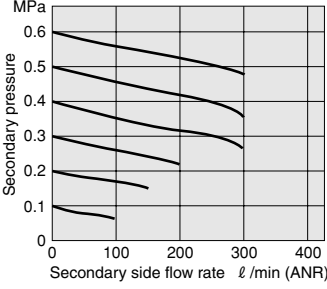

● HRS101-M5

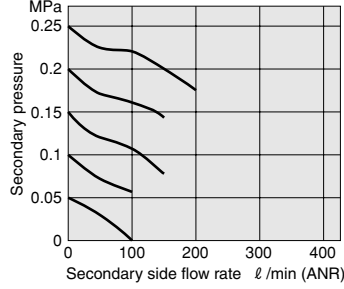

● HRS110-M5-TF

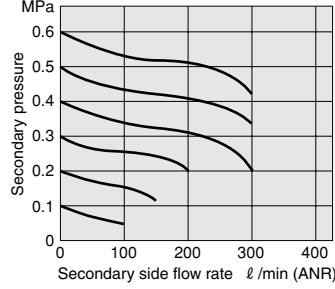

● HRS111-M5-TF

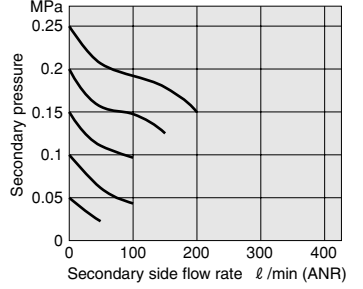

● HRS100-01

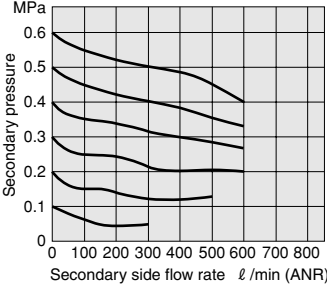

● HRS101-01

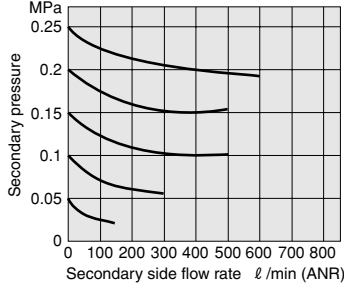

● HRS110-01-TF

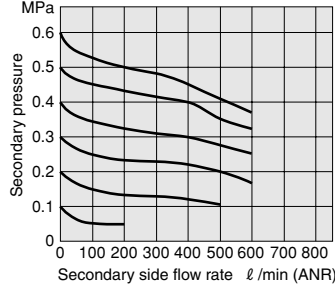

● HRS111-01-TF

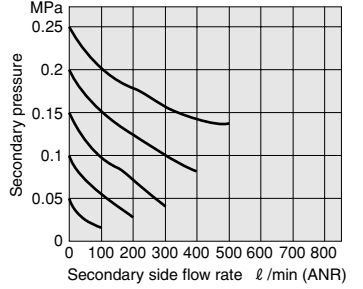

● HRS100-02

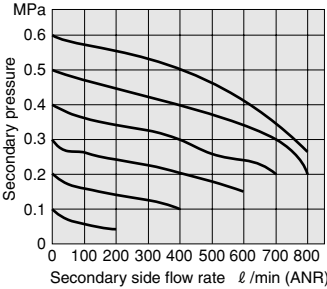

● HRS101-02

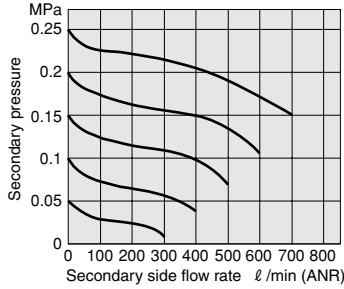

● HRS110-02-TF

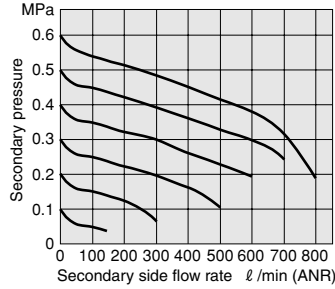

● HRS111-02-TF

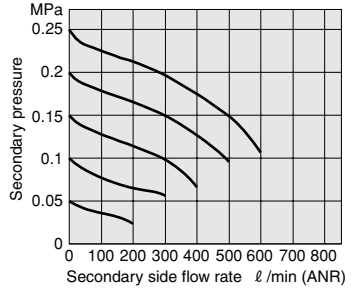

Remark: Graphs show flow rate characteristics when the primary pressure is fixed at 0.7MPa [102psi].

1MPa= 145psi. 1ℓ/min = 0.0353ft<sup>3</sup>/min.

# Pressure Characteristics

● HRS100

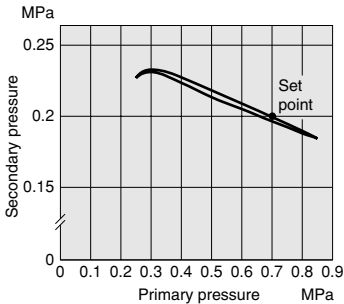

● HRS101

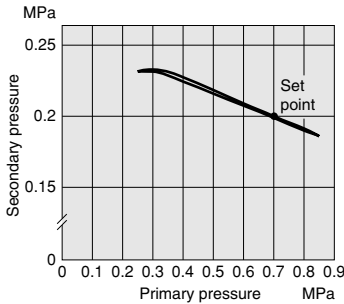

● HRS110-□-TF

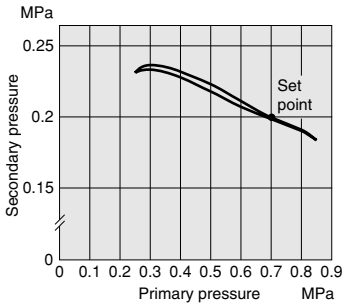

● HRS111-□-TF

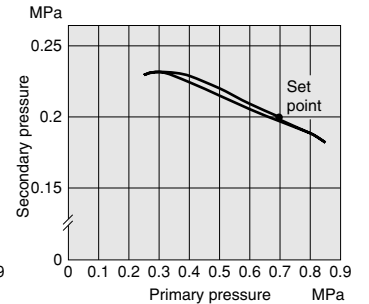

1MPa= 145psi.



## Pressure Gauge Specifications

Item	Model	G1S-40-F11	G3S-40-F11
Media		Air, N <sub>2</sub> , O <sub>2</sub> , CO <sub>2</sub> , He, Ar	
Port size	NPT	1/4	
Pressure indicator range	MPa [psi.]	0~1.0 [0~145]	0~0.3 [0~44]
Accuracy		F.S. ±2.5%	
Outer diameter	mm [in.]	42.5 [1.673]	
Maximum operating pressure	MPa [psi.]	0.93 [135]	0.25 [36]
Operating temperature range	°C [°F]	5~60 [41~140]	
Mass	kg [lb.]	0.091 [0.201]	

## Dimensions of Pressure Gauge (mm)

### ● G1S-40-F11

Standard specification  
1 MPa

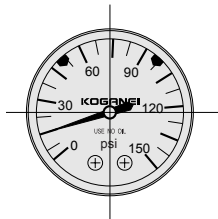

### ● G3S-40-F11

Low-pressure specification  
0.3 MPa

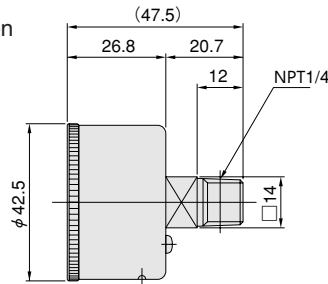
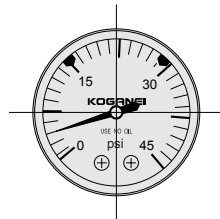

## Major Parts and Materials

Parts	Materials
Case	SPCC (Black painting)
Flats of nipple section	SUS316
Bourdon tube	SUS316
Transparent cover	Plastic (PC)

## Order Codes for Pressure Gauge Single Unit

G□S-40-F11

### Pressure indicator range

- 1 : Standard specification 1 MPa [145psi.]
- 3 : Low-pressure specification 0.3 MPa [44psi.]

## Precautions for Use of Stainless Regulators

### Pressure regulation

1. Always pull out the knob firmly to regulate pressure. Turning the knob to the right (clockwise) increases the pressure, while turning it to the left (counterclockwise) reduces the pressure.
2. After regulating pressure, push the knob back into the body and lock it in place.

### Mounting and piping

1. For the body's piping connection ports, IN is stamped on the inlet port only. Make sure that the corresponding port on the rear of the body is the outlet port.
2. In the case of panel mounting, the panel mounting hole diameter should be  $\phi 24.5$  [0.965in.]. Do not exceed a tightening torque of 980.7N·cm [86.8in.·lbf].
3. For the relieving type, relief air (gas) is exhausted to the outside via the plastic bonnet. Note that this air (gas) cannot be retrieved.
4. When mounting a pressure gauge, use a wrench on the square part of the pressure gauge's piping connection port.

### General precautions

1. Avoid setting the valve in this product's primary side to use that repeatedly switches the primary pressure.
2. Before connecting the piping for the stainless regulator, always flush out the pipes.
3. Usable media includes air, nitrogen, oxygen, carbon dioxide, helium, and argon. Do not use any other media. Moreover, media used for the relieving specifications are limited to air, nitrogen, carbon dioxide, helium, or argon. Do not use any other media.
4. Do not use when the media or the ambient atmosphere contains the following substances: Organic solvents, acids, chlorine, etc.
5. Avoid using in locations where the ambient temperature exceeds the specified operating temperature range.
6. Avoid using when the specified maximum operating pressure is exceeded.
7. This product is for industrial use. Do not use in life-support equipment or other equipment critical to human health and life.
8. Avoid applying excessive external force on this product.
9. Do not disassemble or modify this product.
10. Do not expose this product to ultraviolet rays, wind, or rain.
11. When disposing of this product, always treat it as industrial waste.