

PRESSURE GAUGES WITH BUILT-IN SWITCH

GS1-50

- The set pressure and operating pressure are indicated on the same pressure gauge. Panel mounting offers convenient centralized control and management built into the control panel.
- An indicator is standard equipment, to check the switch operation state. Wiring connection methods offered include a standard grommet (lead wire) type, and a DIN connector type as an option.



Symbol

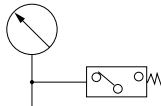

Order Codes

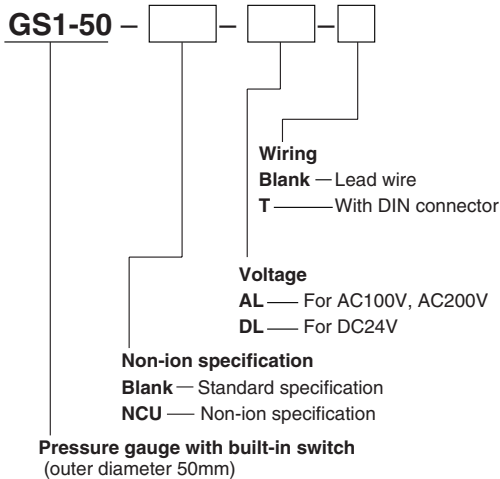

Remark: A model with built-in contact protection circuit (external surge absorption element) is available. For details, consult us.

Specifications

Item	Model	GS1-50
Media		Air
Maximum operating pressure	MPa [psi.]	0.83 [120]
Pressure gauge specifications	Operating temperature range (atmosphere and media) °C [°F]	5~60 [41~140]
	Pressure indicator range MPa [psi.]	0~1.0 [0~145]
	Indicator accuracy	F.S.±3%
	Pressure adjusting range MPa [psi.]	0.1~0.83 [14~120]
Switch specifications	Regulating pressure indication error ^{Notes 1 and 3} MPa [psi.]	±0.05 [±7]
	Repeatability ^{Note 3} MPa [psi.]	±0.05 [7] (5~45°C [41~113°F])
	Hysteresis MPa [psi.]	0.07 [10] max.
	Contact type	Micro switch a contact (NO)
	Wiring	Standard Option
Indicator		Standard equipment: LED for DC, neon lamp for AC
Shock resistance	m/s ² [G]	9.8 [1]
Mounting direction		Any
Mass	kg [oz.]	0.17 [6.0] (0.19 [6.7] with DIN connector)
Materials	Body	Aluminum die-casting
	Case	SPCC
	Flats of nipple section	Brass
	Bourdon tube	Brass

- Notes: 1. Shows when the pressure is rising.
 2. Made to order is available at -1L: 1000, -2L: 2000, -3L: 3000mm.
 3. Regulating pressure indicator errors and repeatability errors could be accumulated. (Maximum ±0.1MPa [±14.5psi.]). Be aware of this during use.

Operating Current Range

Rated voltage		DC30V	AC125V	AC250V
Operating current range				
Inductive load	Continuous	0.05~0.1	0.01~0.1	0.01~0.05
	Inrush	0.5 MAX.	0.5 MAX.	0.2 MAX.
Non-inductive load		0.01~0.5	0.01~0.3	0.01~0.2

Dimensions (mm)

GS1-50

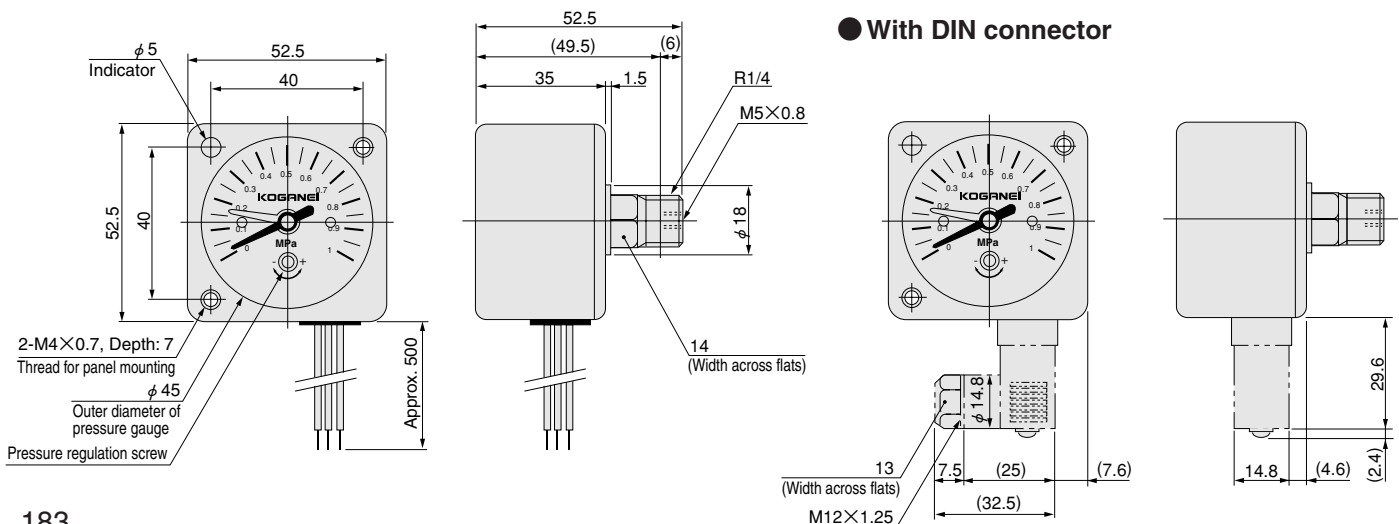

Handling Instructions and Precautions



Pressure gauges with built-in switch

Mounting and piping

1. While any mounting direction is acceptable, install a throttle mechanism in cases where pressure pulsation is particularly severe, such as when mounted between a valve and an actuator. For mounting in locations subject to strong vibrations, consult us.
2. During mounting and piping operations, do not grab the pressure gauge body to tighten. For tightening, always use a hexagonal wrench on the piping connection port section.

Pressure regulation

Rotate the pressure regulation screw, align the regulating pressure indicator (red) to the set pressure, and set. Rotating the pressure regulation screw to the left (counterclockwise) sets to a higher pressure, and rotating it to the right (clockwise) sets to a lower pressure. When the air pressure rises to the set pressure, the switch is activated, and when it falls to the setting pressure of 0.05MPa [7psi.], the switch is returned to the original state.

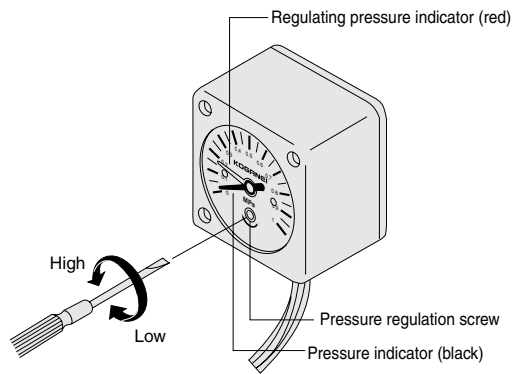

- Cautions:**
1. To regulate the pressure, do not remove the cap on the lens surface, but insert a small screwdriver into a slit in the cap instead, and directly rotate the pressure regulation screw.
 2. The pressure needle has an indication error of 0.05MPa [7psi.]. For fine-tuning adjustment, apply compressed air at the set pressure to check the switch triggering action.

Switch setting method and operations

Setting example: Want the switch to activate when the pressure is at 0.3MPa or less.

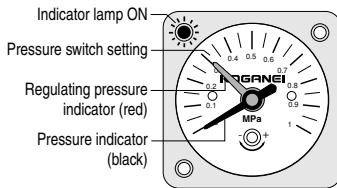

● DC24V

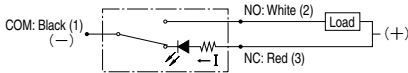

● AC100V, AC200V

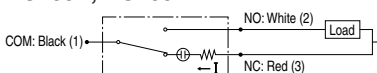

Set the regulating pressure indicator (red needle) to 0.3MPa [44psi.]. But because the regulating pressure indicator has a maximum error of 0.05MPa [7psi.], always apply compressed air regardless of the position the needle is pointing to on the indication scale, adjust the pressure, and use a multimeter, etc., to check whether the built-in switch goes to OFF when the pressure drops to 0.3MPa [44psi.] or below.

When the pressure is in the range of 0MPa ~ 0.3MPa [0 ~ 44psi.], the built-in switch remains at NC, as shown in the circuit diagram above, and the indicator lamp lights up.

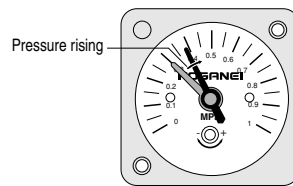

● DC24V

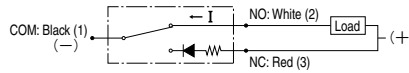

● AC100V, AC200V

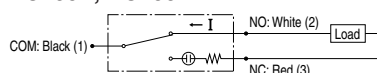

When the pressure rises, and the regulating pressure indicator (red needle) exceeds 0.3MPa [44psi.], the built-in switch flips to NO, as shown in the circuit diagram above, the load current flows, and the indicator lamp goes out.

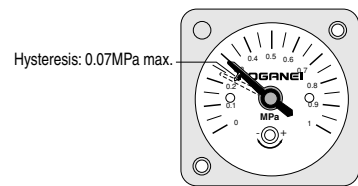

When the pressure falls, and the pressure indicator (black needle) is higher than the regulating pressure indicator (red needle), the internal switch changes to NC with a maximum hysteresis of 0.07MPa [10psi.]. At this time, the repeatability is a maximum ± 0.03 MPa [± 4 psi.].

Note that NC cannot be used as a load contact. Use the switching of NO to OFF to control the relay or other B contact.

To obtain finer accuracy than the above example, we recommend using:

- Digital pressure gauge with built-in sensor
- Digital pressure switches

General precautions

1. Use this product to check the supply pressure. For use in precision control circuits, consult us.
2. Switch performance may be degraded in installation locations where the temperature is higher than 45°C [113°F] or where the humidity is constantly 50% or less. For use in these kinds of places, consult us.

Wiring instructions

Pay attention to the NC and NO contacts and the colors of lead wire (in wires with connectors, the terminal numbers) for wiring. In the figure below, the numbers in parentheses () represent the terminal numbers, while the arrow \uparrow shows the direction of rising pressure. The indicator lamp switches off when the value is at the set pressure or higher, and lights up as a warning when the value falls below the set pressure.

● DC24V

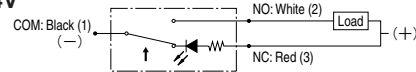

● AC100V, AC200V

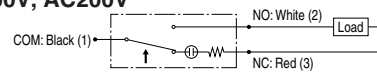

● Wiring instructions with DIN connector

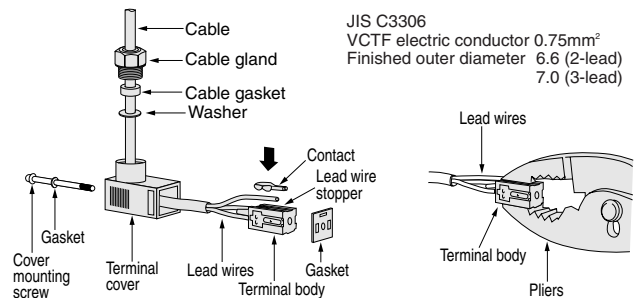

When peeling off the sheath (for cabtyre sheath only), pay attention to the lead wire bending direction. Setting the outer lead wires inside the terminal cover to be about 8mm longer than the inner wires can make it easier to mount the terminal body onto the terminal cover. Without peeling off their insulations, insert the lead wires into the terminal body until they bump up against the lead wire stopper, lower the contacts from above to exposed wires, and use pliers to push them into firm contact, so that the contacts are touching the exposed wires.

Caution: For the connector type, the connector wiring position at time of delivery is in the connecting thread side (back side).