

Owner's Manual

Air Gun Type Ionizer [DTY-ELG41]

Thank you for purchasing the DTY-ELG41. This product is not specified to electric equipment standards as a high-voltage device, but it does handle high AC voltages of approximately 2,500 V or more. Please be sure to read this instruction manual before using the product, so that you can fully understand its functions.

In addition, keep this manual in a safe place.

1. Safety precautions

High voltages are used inside this product, such that incorrect usage could lead to personal injury or damage to the product. Koganei bears no responsibility if the product is used outside its specifications or if the safety precautions are not observed.

⚠ DANGER	Expresses situations that can be clearly predicted as dangerous. If the noted danger is not avoided, it could result in death or serious injury. It could also result in damage or destruction of assets.
⚠ WARNING	Expresses situations that, while not immediately dangerous, could become dangerous. If the noted danger is not avoided, it could result in death or serious injury. It could also result in damage or destruction of assets.
⚠ CAUTION	Expresses situations that, while not immediately dangerous, could become dangerous. If the noted danger is not avoided, it could result in light or semi-serious injury. It could also result in damage or destruction of assets.
⚠ ATTENTION	While there is little chance of injury, this content refers to points that should be observed for appropriate use of the product.

1.1 ⚠ Danger

Do not use in locations where explosives, flammables, or other dangerous substances are present. This product is not an explosion-proof type unit. Explosion or ignition may occur.
When any wiring, installation, or inspection work is to be carried out, make sure that the unit is disconnected from the power supply, otherwise, an accident, an electrical shock or a malfunction may be caused.
Never attempt to remodel the product. It could result in abnormal operation leading to injury, electric shock, fire, etc.
Do not splash water on the product. Spraying it with water, washing it, or using it underwater could result in malfunction of the product leading to injury, electric shock, fire, etc.
High voltages are applied to the discharge needle, so do not put it near electrically conductive materials, such as your fingers, body, wires, or tools. Doing so could result in electric shock or malfunction.

1.2 ⚠ Warning

Do not use the product in excess of its specification range. Doing so creates the risk of product breakdown, loss of function, or damage. It could also drastically reduce the operating life.
The tip of the discharge needle is sharp, so be careful when handling it. This could result in personal injury.
Always supply compressed air before supplying electric power. Supplying electric power while no compressed air is supplied may result in a discharge that increases internal ozone density that produces a bad effect on the devices and environment.
When using the product, do not point the nozzle at people, especially their face or eyes, etc. This could result in personal injury.
Cables that are damaged by being bent excessively, pulled, rolled up, placed under heavy objects, or squeezed between two objects create the risk of current leaks or defective continuity that could result in fire, electric shock, or abnormal operation.

1.3 ⚠ Caution

The ionizer generates ozone while exposed to the atmosphere. If you are using only one ionizer, the density will not saturate and rise above a set point. However, if multiple units are being used and you smell ozone, ventilate the area. Also, do not place your face near the nozzle of the ion air blower to confirm the smell of ozone. Your nose and throat could become sore.
--

1.4 ⚠ Attention

Equipment and parts used near the ionizer (especially ones with low ozone resistance such as NBR) should be checked periodically for ozone degradation.
When the product can no longer be used or is no longer necessary, dispose of the consumables appropriately as industrial waste.
Do not wire parallel to power lines or high-voltage lines. Inductive noise could cause erratic operation.

*Regarding dangers, warnings, and cautions not noted above, refer to the "Safety Precautions (Common to All Ionizers) and Handling Instructions and Precautions (Common Precautions)" in the Static Electricity Removal Unit Ionizers catalog.
(Be sure to refer to the most recent catalog.)

2. Contents of the product set

When you receive this product, before you use it, check whether there are any missing items, and whether there were any abnormalities or damages that occurred during shipping. If there are damages, or if the product does not operate normally, contact your retailer (agent) or our nearest sales office.

- Main unit...1, · Nozzle...1, · Discharge needle*...1, · AC adaptor...1,
 - Owner's Manual (this manual)...1
- *The main unit is installed when shipped.

3. Static charge elimination characteristics

The product's static charge elimination characteristics are shown below.
(DTY-ELG41)

Air pressure [MPa]	0.1	0.2	0.3	0.4	0.5	0.6
+Static charge elimination time [seconds]	0.3	0.2	0.3	0.2	0.2	0.1
-Static charge elimination time [seconds]	0.3	0.2	0.3	0.2	0.2	0.1
Flow rate [L/m (A.N.R.)]	99	159	215	266	320	370

(DTY-ELG41-PAU)

Air pressure [MPa]	0.2	0.3	0.4	0.5	0.6
+Static charge elimination time [seconds]	0.6	0.4	0.4	0.3	0.3
-Static charge elimination time [seconds]	0.6	0.4	0.4	0.3	0.3
Flow rate [L/m (A.N.R.)]	56	79	102	113	118

(*Under Koganei measurement conditions)

- * Measurement distance : 50 mm
- * Measuring device : Charged plate monitor (plate size 150 mm x 150 mm, electrostatic capacitance 20 pF)
- * Static charge elimination time : Attenuation time from ±1000 V to 100 V
- * Φ6 air fitting, Φ6 air tube

4. Specifications

Names of parts

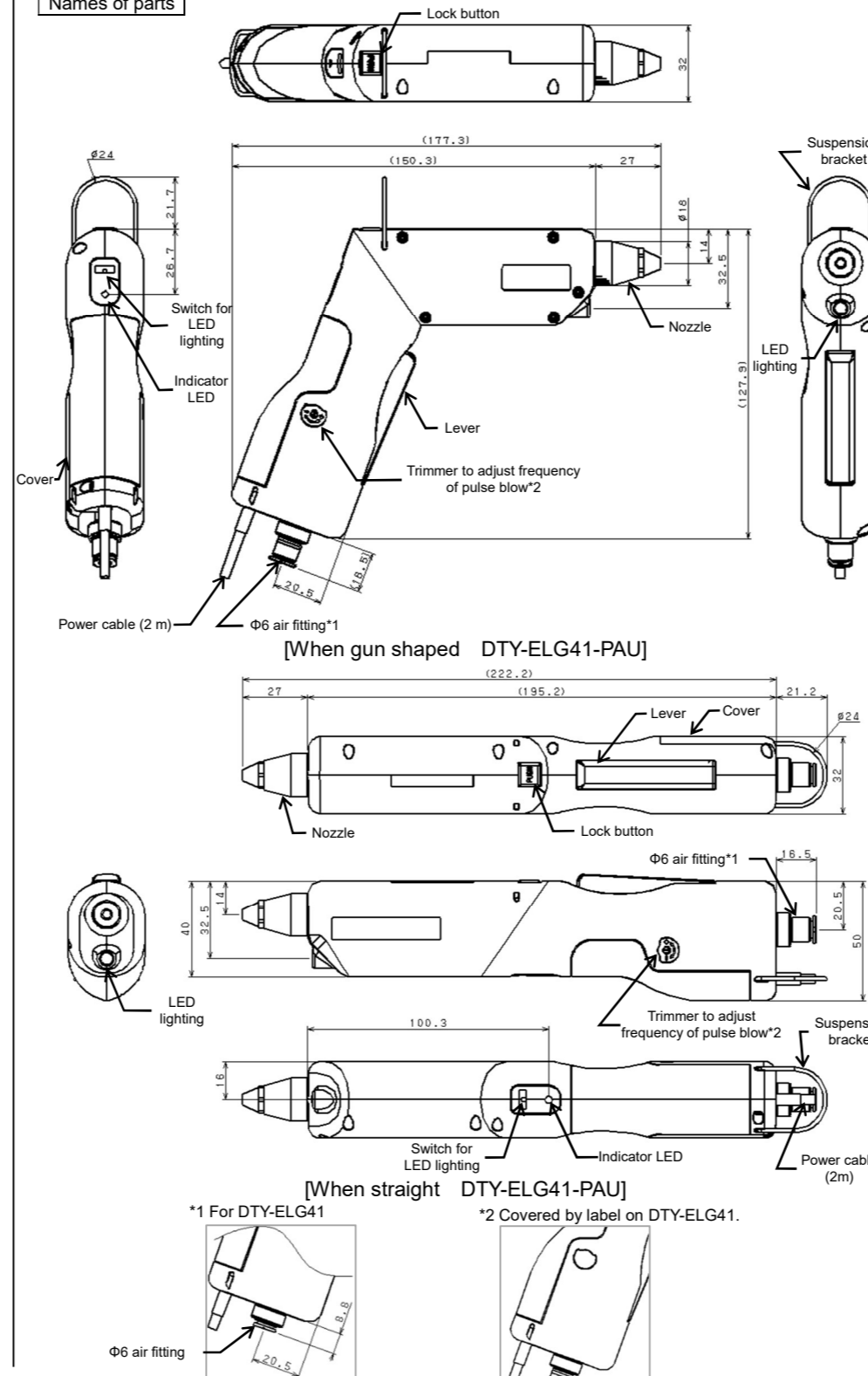

Specifications

Model number	DTY-ELG41	DTY-ELG41-PAU
Ion production method	High-frequency corona discharge	
Power supply voltage	Provided AC adaptor INPUT: AC100 - 240 V, 50/60 Hz, 0.3 A (OUTPUT: DC 24 V, 0.5 A)	
Product input voltage	DC24 V ± 5%	
Consumption current	Less than 100 mA	
Output voltage	2,500V	
Ion balance	±15V *	
Medium used	Air (clean air that contains no moisture or oil)	
Operating air pressure range	0.05 - 0.6MPa	0.2 - 0.6MPa
Air flow rate	Maximum 370 ℓ/min (ANR)	Maximum pulse flow rate 120 ℓ/min (ANR)
Dimensions of main unit (excluding protrusions)	Gun-shaped: 177.3 (L)×32 (W)×127.9 (H) Straight: 222.2 (L)×32 (W)×50 (H)	
Weight	Approximately 185g (cable not included)	Approximately 235 g (cable not included)
Pulse blow	-	Frequency of pulse blow 5 Hz to 15 Hz *
Usage environment	Indoors, altitude of 2000 m or less, pollution degree 2 (according to IEC61010-1)	
Temperature in usage environment	0 - 40°C	
Humidity in usage environment	65% or less (Non-condensation)	
Indicators	Green: indicates power/discharging; red: indicates abnormal display	
Lighting	LED for lighting (white)	
Switch for LED lighting	Switch for LED lighting (3 positions) Always off/always on/synced to lever	
Amount of ozone generated	0.04 ppm or less (when 200 mm from tip of nozzle, 0.2 MPa air pressure)*	
Material	Main unit: PBT, nozzle: PPS	

*Under Koganei measurement conditions.

5. Wiring and Piping

⚠ WARNING

- Always supply air to the product whenever it is turned on. Furthermore, when using the product adjust the air flow rate to be 60 ℓ/min (ANR) or more.
- Do not remove and replace the air fitting on the main unit. Doing so could result in damage to the main unit.

⚠ CAUTION

- Do not install the product where it could be splashed by water or oil; locations where condensation forms easily; or locations exposed to severe changes in temperature or humidity. Doing so could damage the product.
- Be sure to use the dedicated AC adaptor. Otherwise, the product could break down, its functions could stop, or it could be damaged.
- Use clean air, from which oil and moisture have been removed, as the medium. Using air that contains water or oil could result in the nozzle and interior of the main unit becoming dirty, the static discharge performance falling, or the main unit deteriorating.

Installation

Hold the product in your hand and use it the same way as a regular air gun. Also, the main unit can be hung by its suspension bracket. The suspension bracket can be moved for hanging while either straight or gun-shaped. Change the position of the suspension bracket according to your application.

To remove the suspension bracket, pull it open from both sides as shown in figure 1.

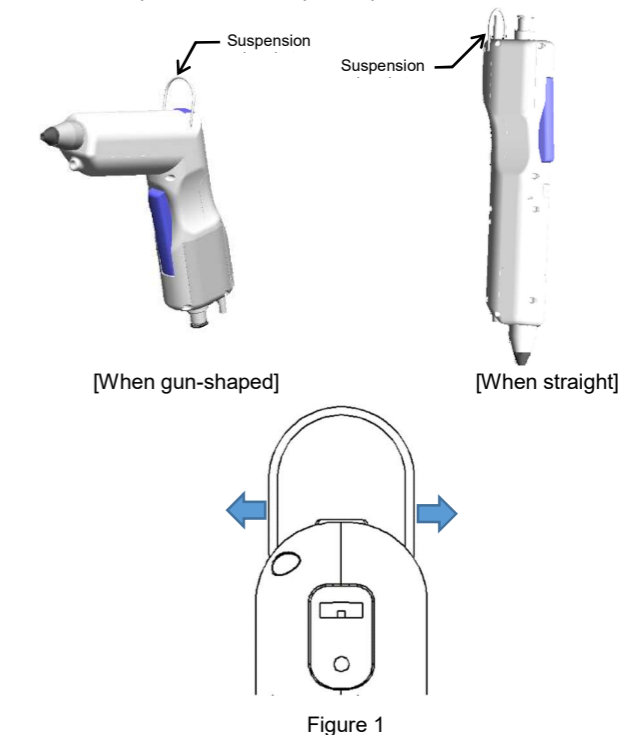

Electric Wiring/Air Piping

Connect the main unit and the AC adaptor according to the wiring diagram below.

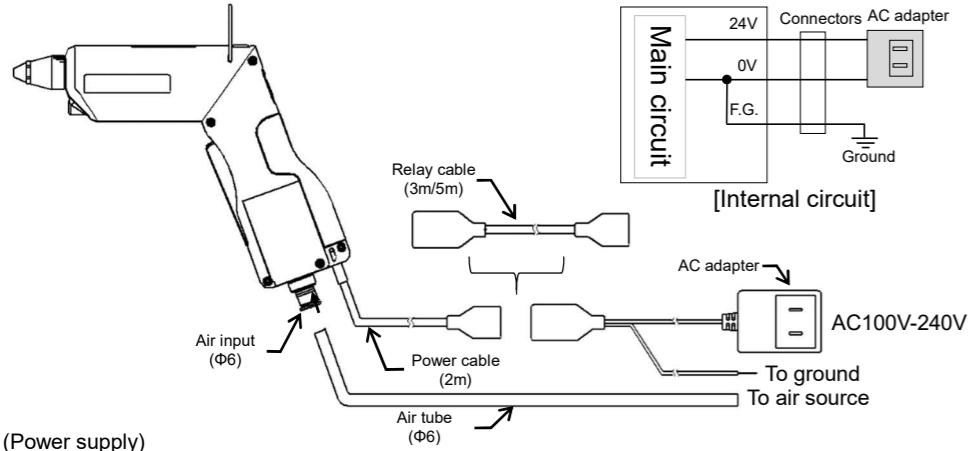

(Power supply)

- Connect the AC adapter connector to the power cable of the main unit. Insert the connector covers into each other so no dust gets inside.



- Connect the ground cable (green wire).
Note) 0V (AC adapter output) and F.G. (frame ground wire) are connected inside the main unit. Static charge removal performance is reduced when not fully grounded.
- Connect the AC adapter to the power supply (AC 100 V - 240 V, 50/60 Hz).
- When using the relay cable, connect it between the AC adapter connector and the power cable of the main unit.

Note) The AC adapter cable is not a flex resistant cable. If there is a risk of the cable moving, then secure the AC adapter cable or the connectors. The main unit cables and relay cable are flex resistant. The cable bending radius must be 32 mm or above.

(Air)

- Use clean air, from which oil and moisture have been removed, as the medium.
- Attach the air tube (φ6-mm outer diameter) to the air fitting on the main unit. (Urethane tube recommended: Urethane tube/nylon tube)
Note) The air tube length must be 3m or shorter.
- Install a regulator between the air tube and the air source.
- Do not excessively bend or twist the Φ6mm air tube near the fitting. Doing so may result in air leakage. When using nylon tubes, the minimum bending radius is 30mm.

6. Operations

⚠ WARNING

- When using the product, do not point the nozzle at people, especially their face or eyes, etc. This could result in personal injury.
- Use protective glasses and ear plugs because there is a risk of noise causing hearing impairment or debris being blown into your eyes.

⚠ CAUTION

- Do not drop or hit the air gun because there are piezoelectric ceramics inside it.
- The nozzle on the tip of the main unit is connected to internal circuits, so do not let it touch live wires or conductors.
- Use only the specified nozzle. Do not modify the nozzle. Otherwise, the product could break down, its functions could stop, or it could be damaged.
- If the power/discharge indicator LED (green) does not light or if the error indicator LED (red) lights, immediately turn off the power and refer to "5. Wiring and piping for installation" in this document. If the issue cannot be resolved, refer to "7. Maintenance" and "8. Troubleshooting" in this document.

Operations

- Press the lock button on the main unit to change to gun shape or straight. When gun-shaped, while pressing on the lock button, rotate the grip side 180 degrees in the direction of arrow 1 to switch to the straight shape, as shown in figure 2. When straight, while pressing on the lock button, rotate the grip side 180 degrees in the direction of arrow 2 to switch to the gun shape. After rotating, the lock button clicks so you can confirm it is locked. Always press the lock button all the way in when rotating. Rotating while the lock button is not pressed or in the opposite direction causes damage.

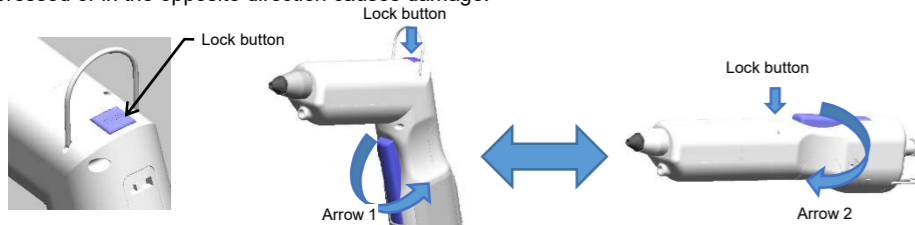

Figure 2

- Check the electric wiring and air piping.
- Supply air that is being regulated by a regulator to the main unit. Be sure to set the pressure being applied to within the operating pressure range.
- Supply power (AC 100 V - 240 V, 50/60 Hz) to the AC adapter.
- Hold the main unit firmly, point the nozzle at the workpiece, and then squeeze the lever.
Note) Do not grip the tip part of the main body, since it may effect on the ion balance.

The power/discharge indicator LED (green) lights and ionized air sprays from the tip of the nozzle. To stop the ionized air, release your grip on the lever. The lever returns to its original position, the power/discharge indicator LED goes out, and the ionized air stops.

State	Indicator		Description
	Green	Red	
Energized state (power on)	⊙→○	○	When the power is turned on, the green LED flashes for 2 seconds, and then turns off.
Lever on	●	○	The lever is on, discharging is normal, green LED is lit.
Discharge abnormality	○	●	Discharge abnormality occurred while discharging. Red LED lights during abnormality.

●: ON ○: Off ⊙: Flashing

- There is an LED for lighting on the end of the main unit.

The LED for lighting is turned on/off according to the position of the lighting switch.

Switch position	LED		
	ON	OFF	SYNC
Label	ON	OFF	SYNC
LED for lighting (white)	Always on	Always off	Synced to lever On/off

- You can adjust the pulse frequency by turning the adjustment trimmer on the side of the main unit. Use a precision flathead screwdriver to adjust it.
When using supported models: DTY-ELG41-PAU/DTY-ZPA-G31

Toward + (counterclockwise): Frequency increases.
Toward - (clockwise): Frequency decreases.

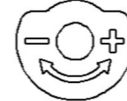

- Note) Squeeze the lever in a single motion. A pulse blow may not occur if you squeeze it slowly.
Note) The trimmer increases frequency when turned counterclockwise and decreases when turned clockwise. The component parts of the trimmer may be damaged if you fully open or fully close it and then turn it further.
Note) Piping conditions may cause variations in frequency characteristics and flow rate characteristics. Use a Φ6 air tube that is less than 3 m long.

Replacing the in port/pulse blow unit

Example) Replacing an in port (DTY-ZNP-G31) with a pulse blow unit (DTY-ZPA-G31)
*Use the same procedure to replace the pulse blow unit with an in port.

- Remove the screws on the side of the main unit. To remove the cover, lift it in the direction of the arrow.

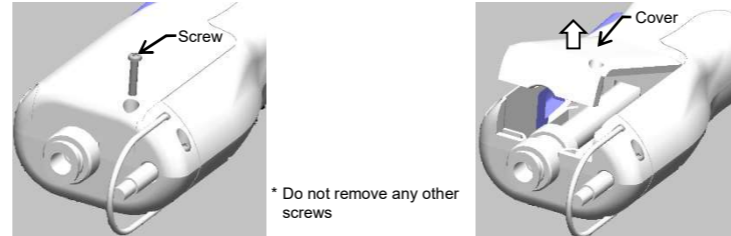

- Lift the in port in the direction of arrow 1 to remove it in the direction of arrow 2 from the semi-circle area. Peel off the label that is on the pulse blow frequency adjustment trimmer.



- Align the protruding tip of the pulse blow unit with the insertion hole on the main unit, and press it in, in the direction of arrow 3. While pressing in, press down in the direction of arrow 4, and put it into the semi-circle area.

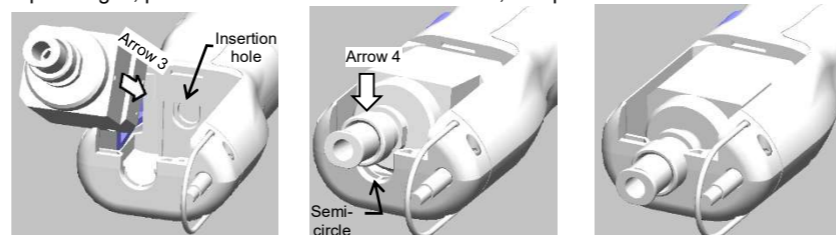

- Confirm that it is fully in the semi-circle, and then close the cover. If you cannot close the cover at this point, the pulse blow unit may not be inside the semi-circle, so put it in again. Fasten the cover with the screw.
(The main unit may be damaged if the correct tightening torque of 15 to 20 N·cm is not used.)

Note) If you changed from the pulse blow unit to the in port, then put the label provided on the pulse blow adjustment trimmer, which is on the side of the main unit.

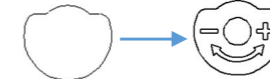

If you changed from the in port to the pulse blow unit, then remove the label that is covering the frequency adjustment hole to use it.

7. Maintenance

⚠ WARNING

- Always turn off the air and the power before doing maintenance work. This can lead to malfunction or accident.
- The tip of the discharge needle is sharp, so be careful when removing and cleaning it.

⚠ CAUTION

- Fully ventilate the area when using alcohol, etc. Also, after cleaning with alcohol, allow the main unit to fully dry, and check that it is not wet.
- Never use a wire brush to clean the main unit, doing so could damage it.
- When installing a nozzle, tighten it by hand until there is no looseness. Do not overtighten it. Also, do not use any tools to tighten it.

Dirt sticking to the discharge needle reduces the static charge removal performance. Clean it periodically, or when the static charge removal performance is low.

Cleaning method

Rotate the nozzle to remove it from the main unit, then use a cloth or cotton swab dampened with alcohol (IPA) to clean the discharge needle (tip) and surrounding area inside the main unit. Allow it to dry completely, and then securely install the nozzle.

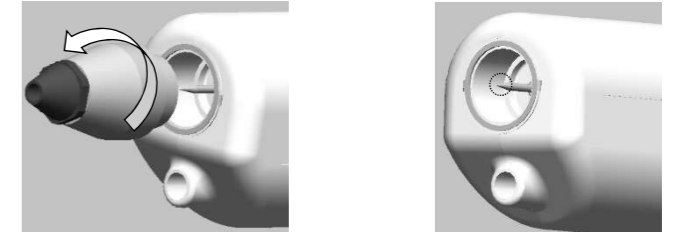

How to replace the discharge needle

The discharge needle is a consumable part that needs to be replaced. When replacing the discharge needle (5 piece set: DTRY-ZEM-G31), always use a combination of the specialized tool (DTRY-ELB21) and a torque screwdriver, and set the tightening torque to 15 to 20 N·cm for the replacement. If the torque is not appropriate, the screw in the main unit may be damaged.

8. Troubleshooting

Symptom	Major cause	Countermeasure
Power does not turn on	Power supply is not connected	Check whether the AC adapter is connected to a power supply. Check whether the main unit and AC adapter connectors are disconnected.
Air does not come out	Air supply is not connected	Check whether compressed air is being supplied.
Error indicator (red) is on	Discharge needle is dirty	Clean the discharge needle (tip) and the area around the discharge needle.
	Discharge needle short circuit	Check whether there is a conductive object near the discharge needle.
	Nozzle is grounded	Do not allow the nozzle to be grounded.
Static charge is not eliminated	Nozzle is loose	Tighten the nozzle securely to the main unit.
	Discharge needle is dirty or damaged	Refer to "7. Maintenance" in this document to replace or do maintenance on the discharge needle.

* Before using the product, refer to the "Safety Precautions (Common to All Ionizers) and Handling Instructions and Precautions (Common Precautions)" in the Static Electricity Removal Unit Ionizers catalog and on our website, regarding precautions for and how to use the product.

* For inquiries about the product, contact our Overseas Department noted below.



KOGANEI CORPORATION

OVERSEAS GROUP
3-11-28, Midori-cho, Koganei City, Tokyo 184-8533, Japan
Tel: 042-383-7271 Fax: 042-383-7276